

TOSOT

Smart Home Instruction

Contents

Ewpe Smart App Operation Manual.....	3
Alexa Instruction.....	4
Google Home Instruction.....	20

Ewpe Smart App Operation Manual

Control Flow Chart

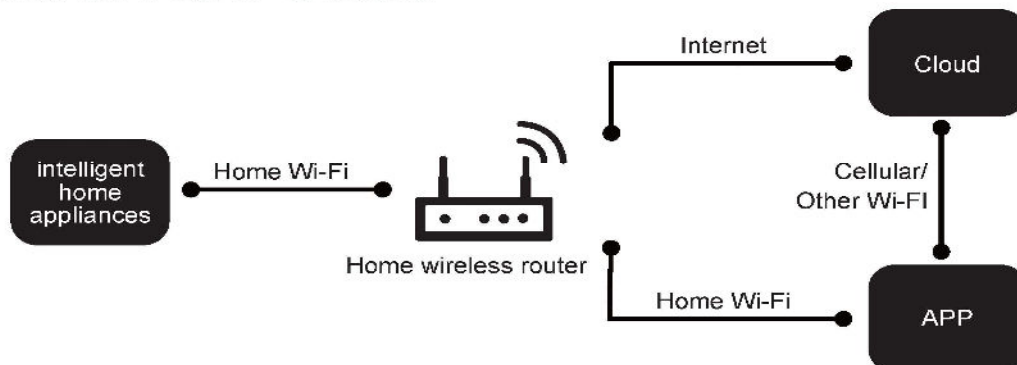

Operating Systems

Requirement for User's smart



iOS system
Support iOS7.0



Android system
Support Android 4.4 and
above version

Download and installation

Scan the QR code or search "Ewpe Smart" in the application market to download and install it. When "Ewpe Smart" App is installed, register the account and add the device to achieve long-distance control and LAN control of smart home appliances. For more information, please refer to "Help" in App.

Alexa Instruction

1. Complete product networking configuration in EWPE App

Complete networking configuration according to the guidance in the App

Note: Revise the device name in the App to the one which is easy for Alexa to recognize, it is English name generally, e.g: "Peter".

2. Amazon Echo device configuration

If you have configured Amazon Echo, you can skip this step, the following statement is mainly for the iOS client.

- Please make sure your Amazon Echo device is energized and connected to Wi-Fi network.
- Open Alexa App on the phone, after successful login, click the menu on the top left corner of Home page, select "Settings" and click "Set up a New Device" to set Amazon Echo device.

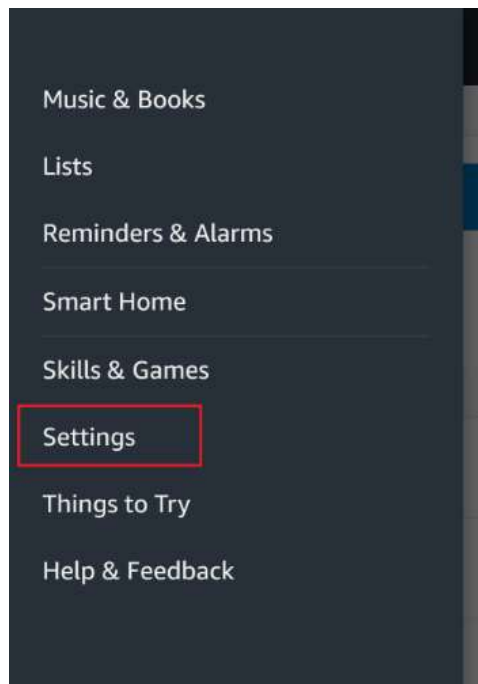

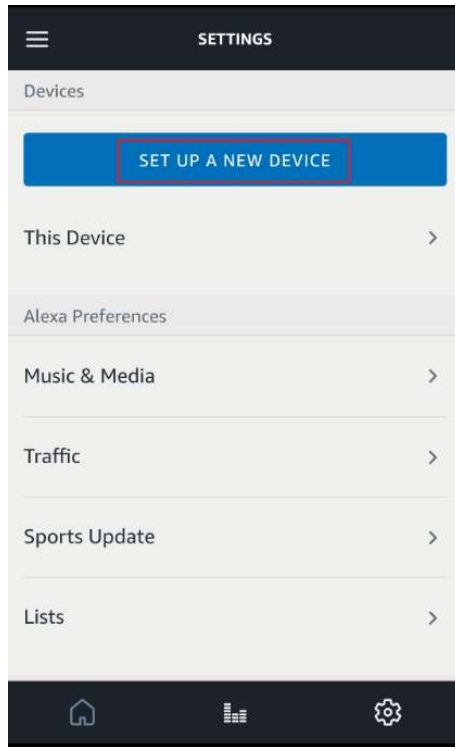

Select Amazon Echo device type and language for networking, according to the operation prompting, long press the small round dot on the device until the light turn yellow, then click "Continue" to enter the connection hotspot.

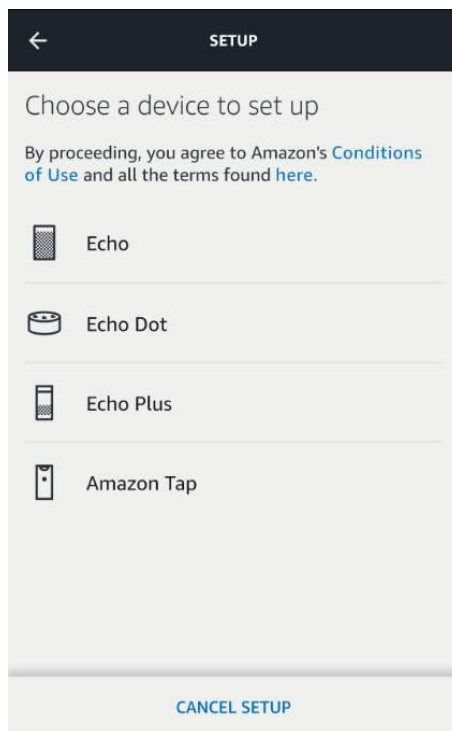

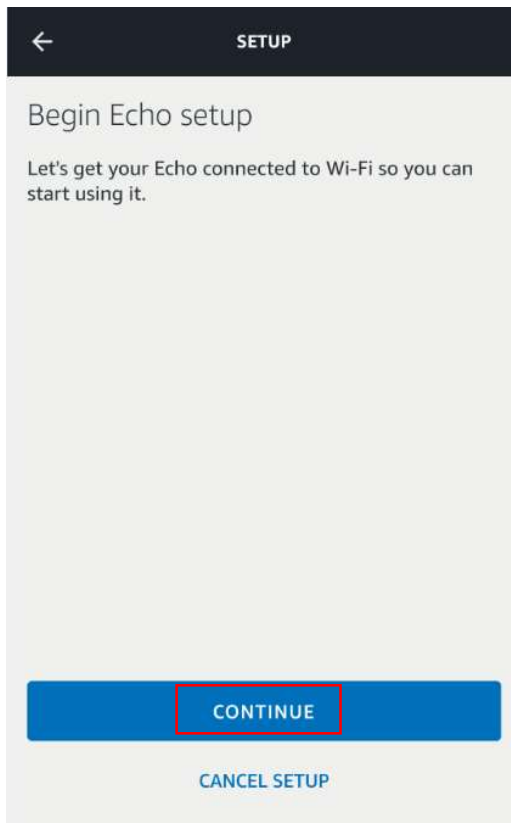
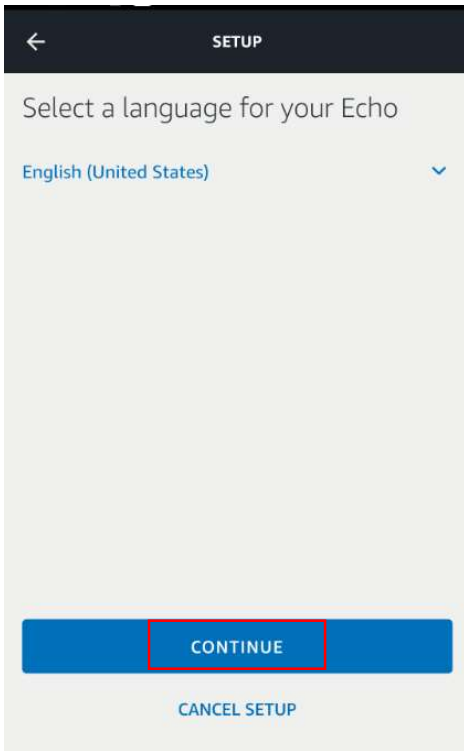

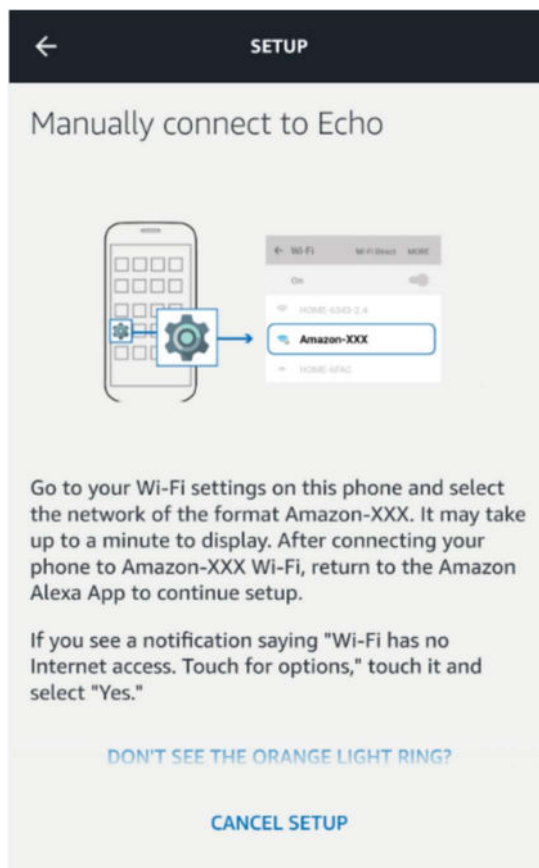
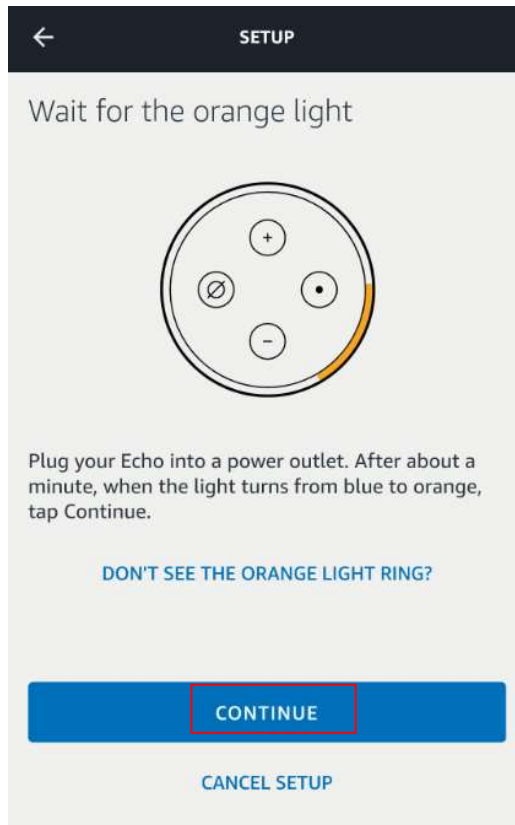

· Return to the page after connecting to the hotspot of Amazon Echo, at this time, the connection is

successful, click “Continue” to enter the next step, select a Wi-Fi network, then Amazon Echo will try to connect the network in several minutes.

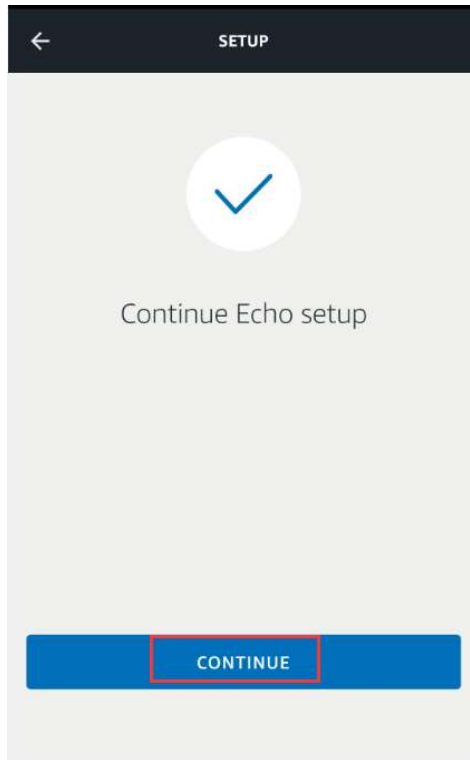

·After the successful network connection, click “Continue”, at this time, an introduction video will appear. After the video, click “Continue” to jump to the Home page of Alexa, then the configuration process of Amazon Echo is finished.

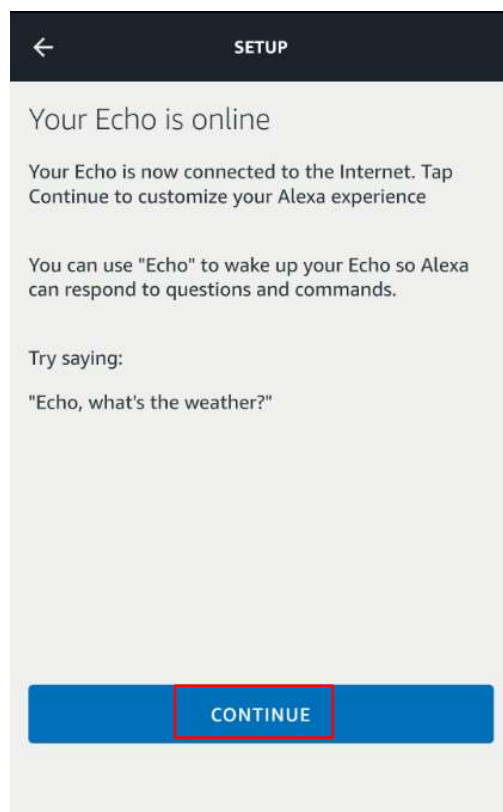

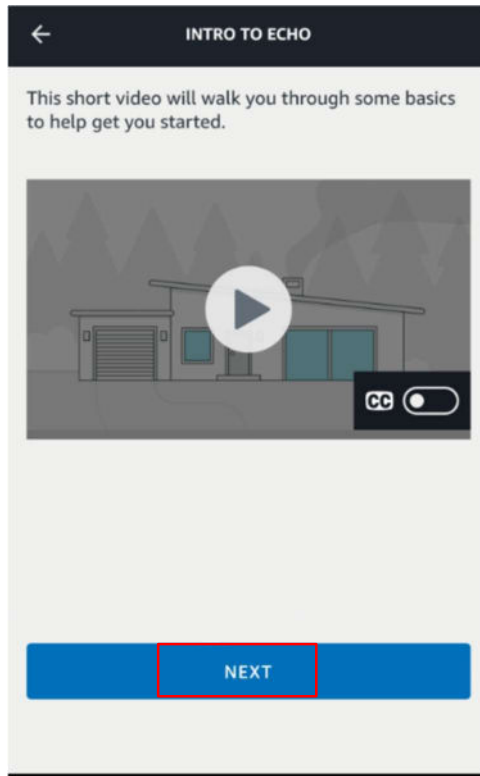

3. Key step——add Skill

·In the menu of Alexa App, click and enter “Skills & Games”.

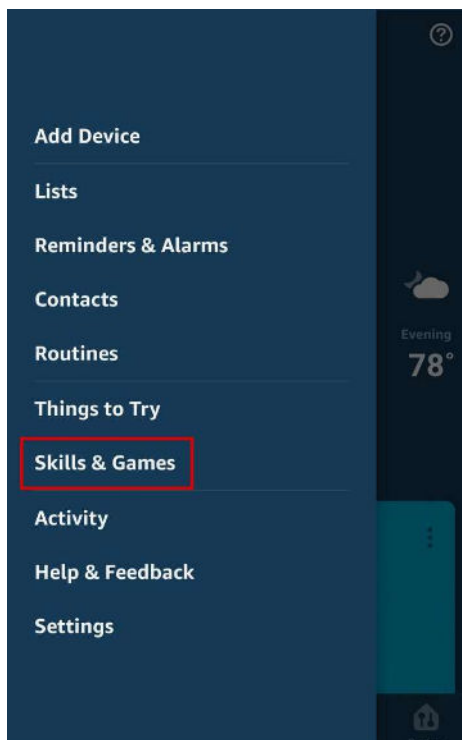

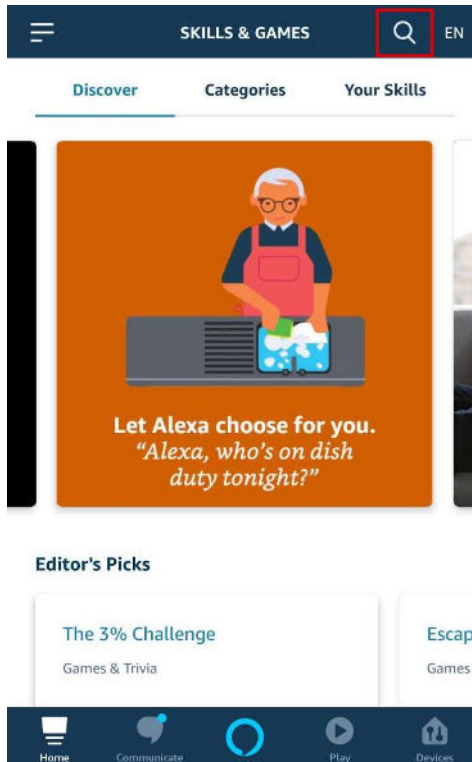

- Search “GREE Smart” or “EWPE Smart ”. Click “ENABLE TO Use” to start Skill.



Search

Keyword or skill name

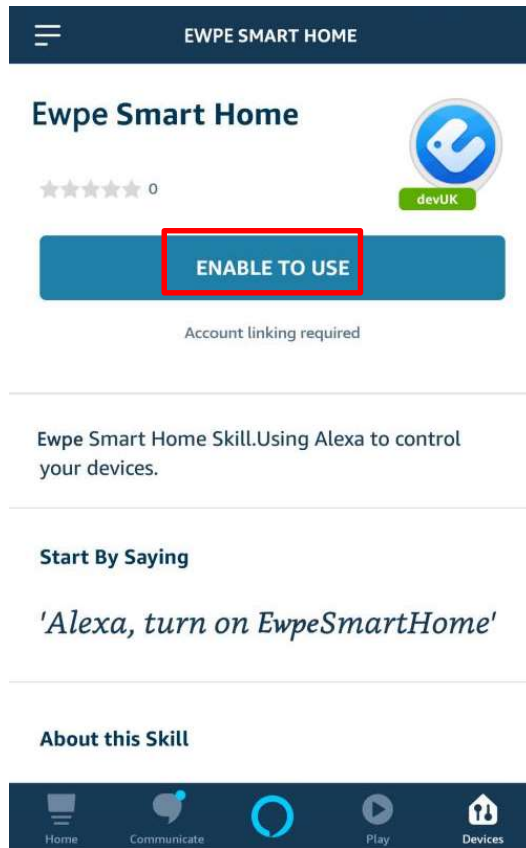

· Input EWPE App account and password, click “Sign in” to add your EWPE App account, then you can start Skill.

User Sign in



* Account

* Password

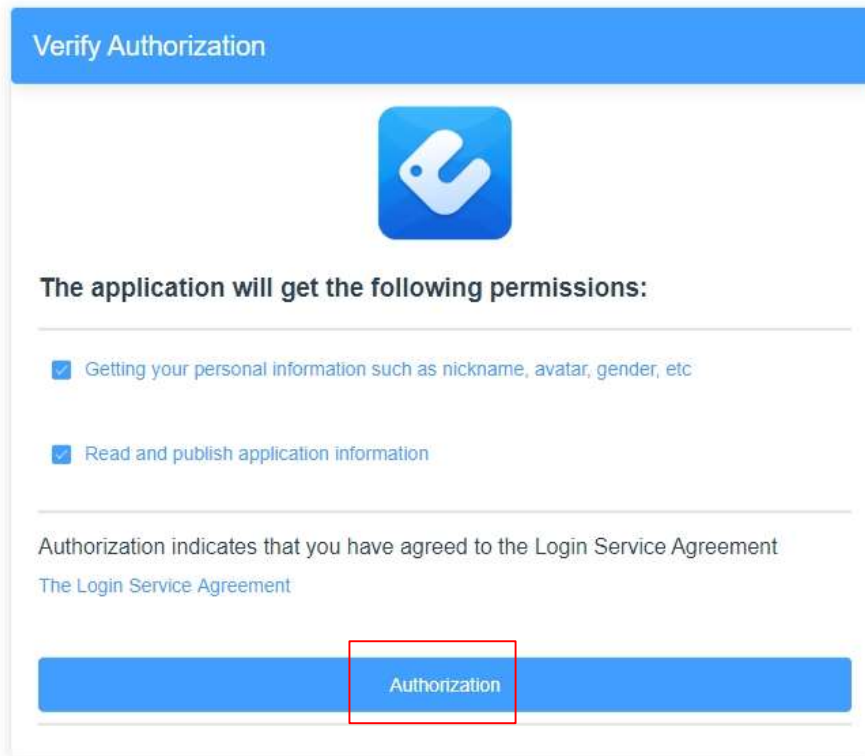

· When the following interface occurs, it means that your EWPE App account has been added with Alexa, click the return button to exit the browser, and re-enter your Alexa App.

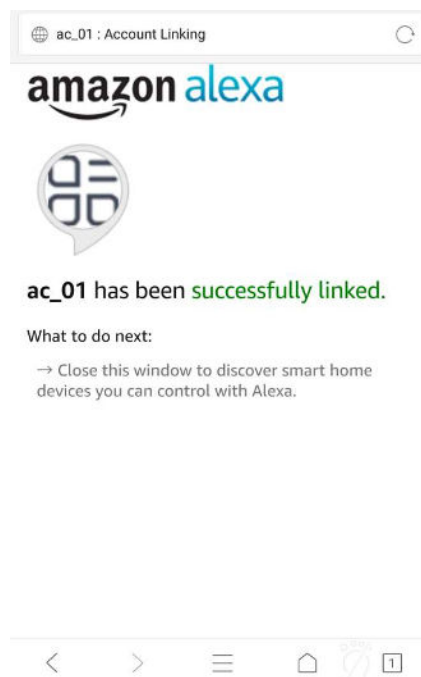

· The following interface will occur, click “DISCOVER DEVICES”, we will search the added intelligent devices on EWPE App account, this process might take some time.



Discover Devices

Smart Home devices must be discovered before they can be used with Alexa.

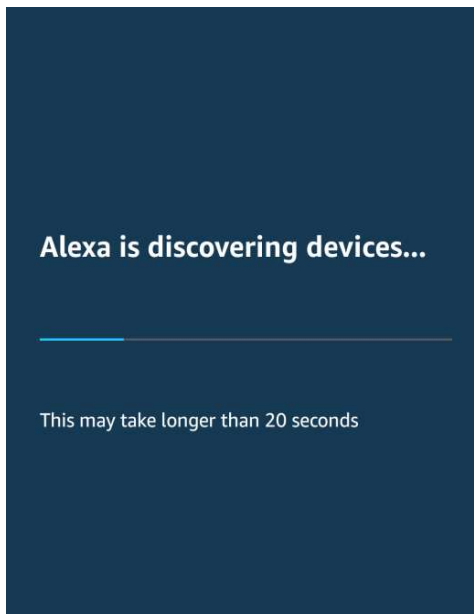

· After searching, click “SET UP DEVICE” to add device, then the prompt on successful device adding will appear, you can control the device through voice; click “DONE”, you can skip or add the intelligent device to current group.

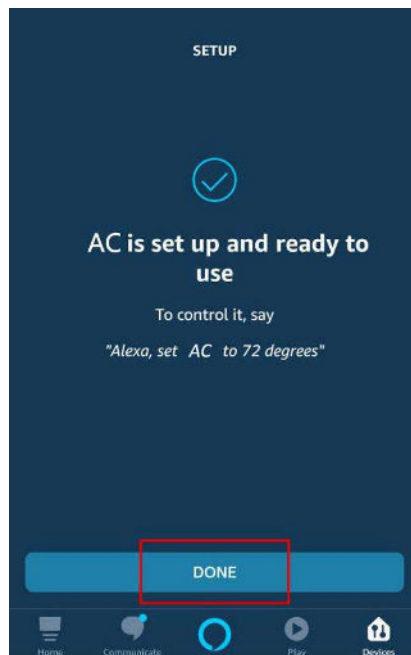
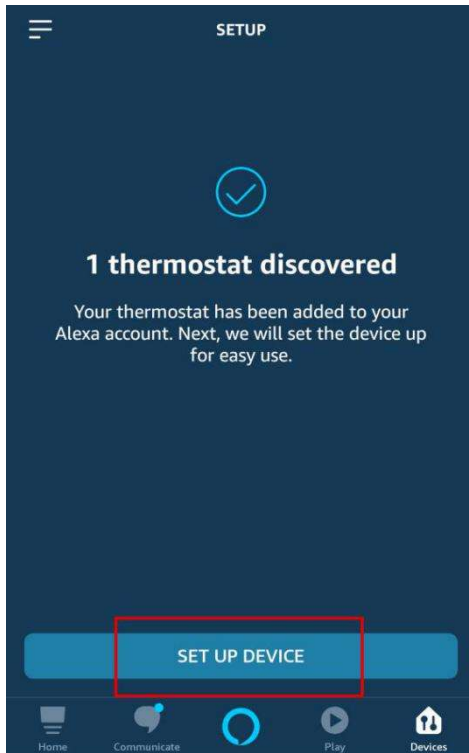

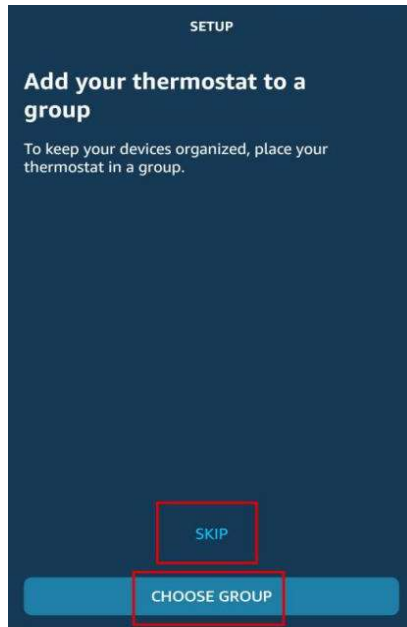

· Return to the menu interface, the prompting on new device will appear, click the voice button at the bottom to conduct voice control.

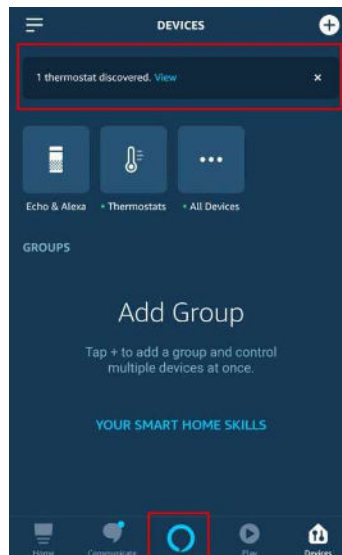

Revise device name: click “Thermostats” to enter thermostat device control interface, click the successfully-added device “AC”, click the setting button on the top right corner, click “Edit Name” to revise device name, then click ENTER and return, the revision is successful.

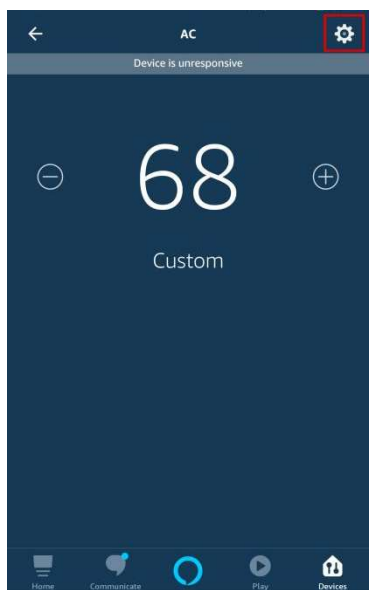
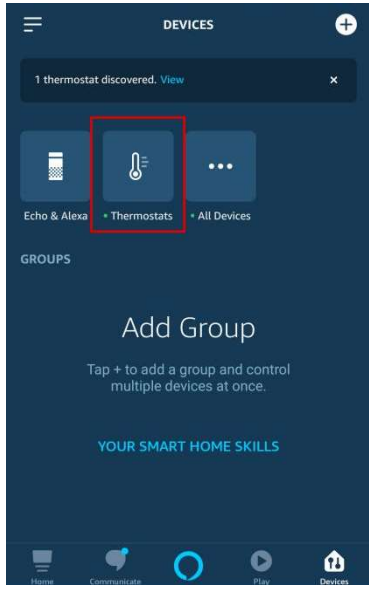

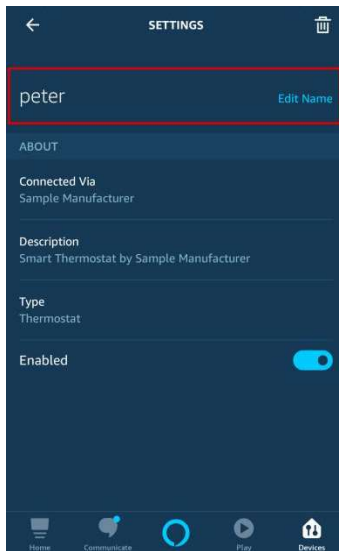
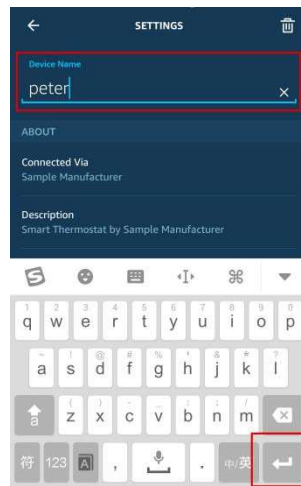
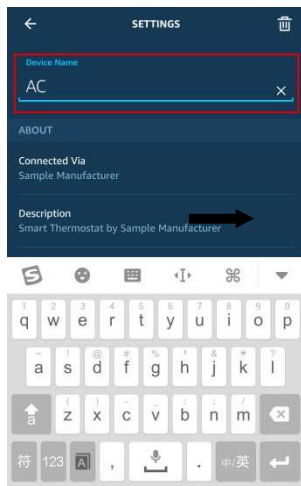
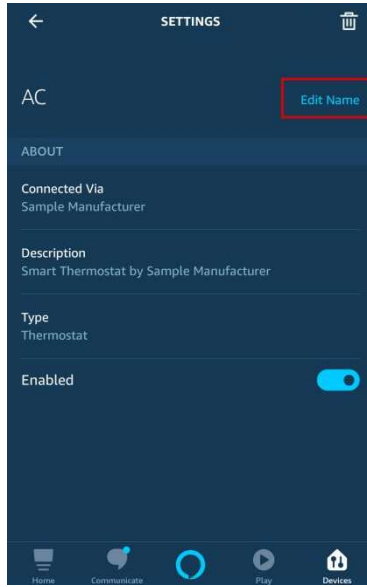



Click the voice control button at the bottom to control the device through voice.

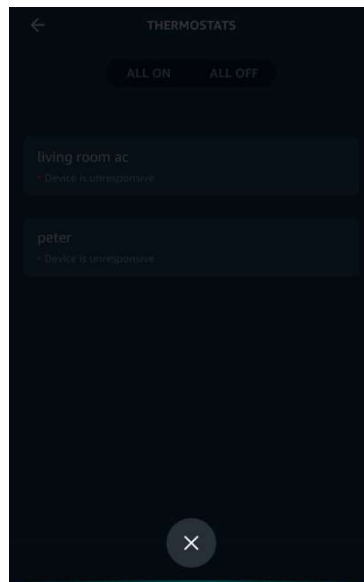

4. Common control words

Control the device through voice, now, you can start to use Echo to control your intelligent device. You can control the device (e.g: AC) through the following instructions:

Turn on/off :

Alexa, turn on/off AC .

Alexa, turn on AC.

Fan speed :

Alexa, set the AC to high.

Mode :

Alexa, set mode on AC to cool.

Temperature :

Alexa, set the AC temperature to 16.

Amazon suggests that don't use AC as the device name, you can name it livingroom AC.

Google Home Instruction

1. Premise

Before using Google Home to control intelligent equipment, please make sure you have satisfied the following conditions.

- Your mobile phone has installed the latest version of Google Home app or Google app (for Android only)
- Your mobile phone has installed the latest version of EWPE app.

2. Complete device networking configuration according to the guidance of EWPE App

Note: Revise the device name in the App to the one which is easy for Google Assistant to recognize, it is English name generally, e.g: "GREE Smart Air conditioning".

3. Google Home configuration

- If you have configured Google Home, you can skip this step, the following statement is mainly for the Android client.
- Please make sure your Google Home device is energized and connected to Wi-Fi network, the four lights on the cover is on.
- Open Google Home App on the phone, after successful login, "Discover" will appear automatically to wait for the Google device to be connected.
- Click "Setup" to start connecting Google Home device.

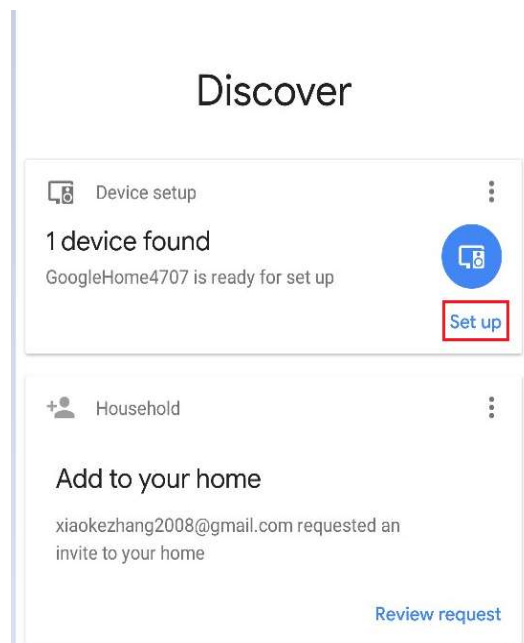

Confirm to add Google Home device and click "Yes".

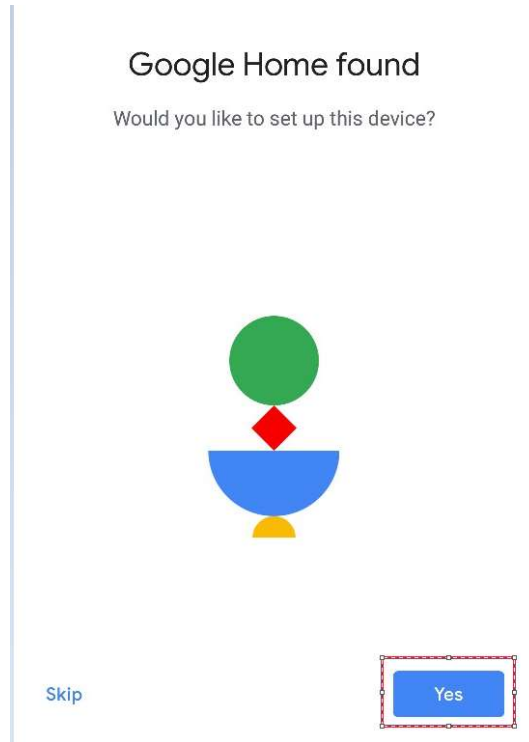

It will give out a sound to confirm that you have connected to the right device. After hearing the sound, click “Yes” to enter the next step.

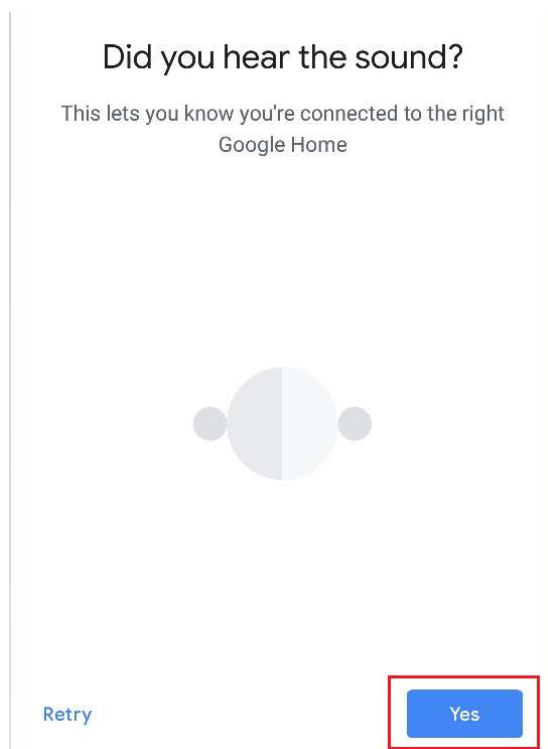

Join in Help Improve Google Home and click “Yes, I’m in” or “No thanks”.

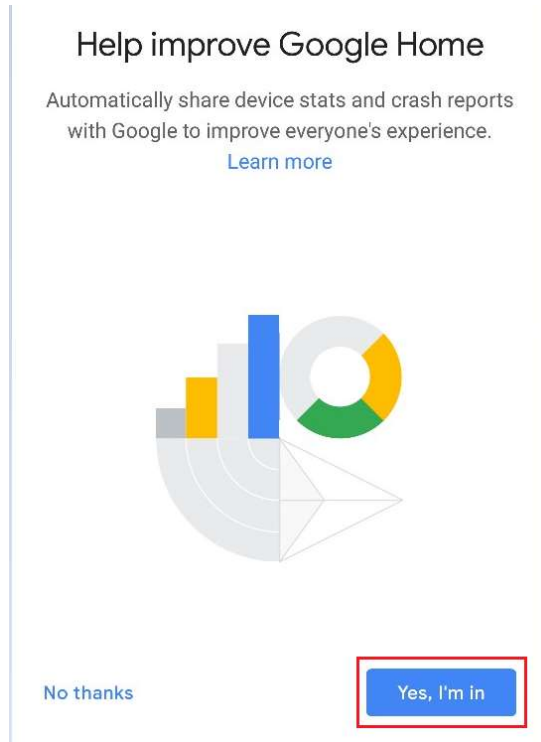

Distinguish the room of Google Home from the other Google device areas, click “NEXT”, revise room name and click “Continue”.

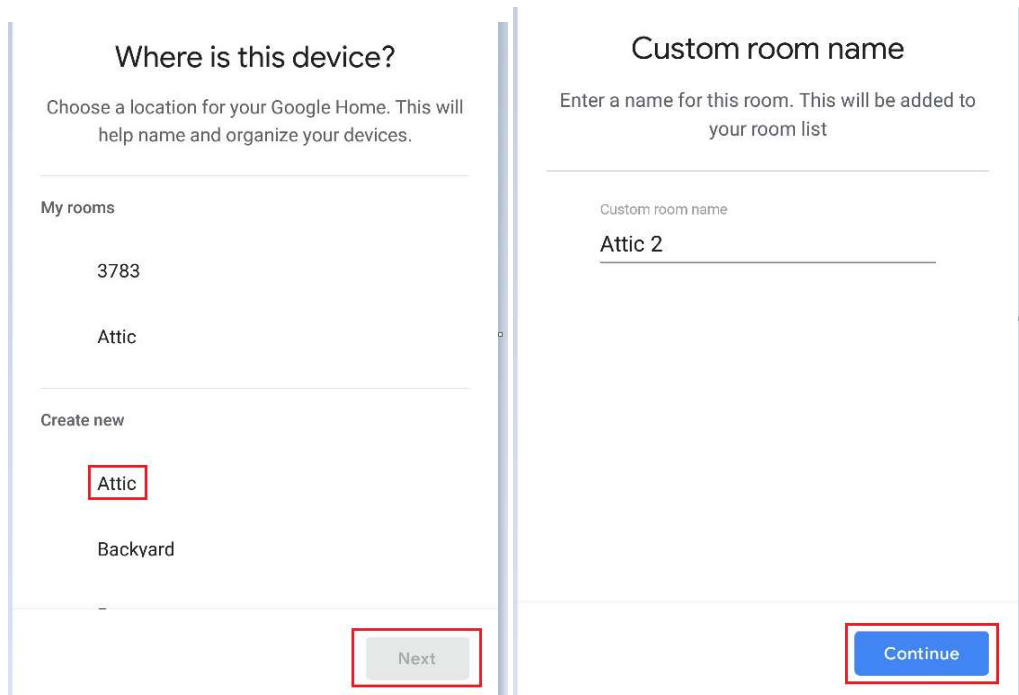

Then select Wi-Fi network and click “NEXT” to wait for device network connection.

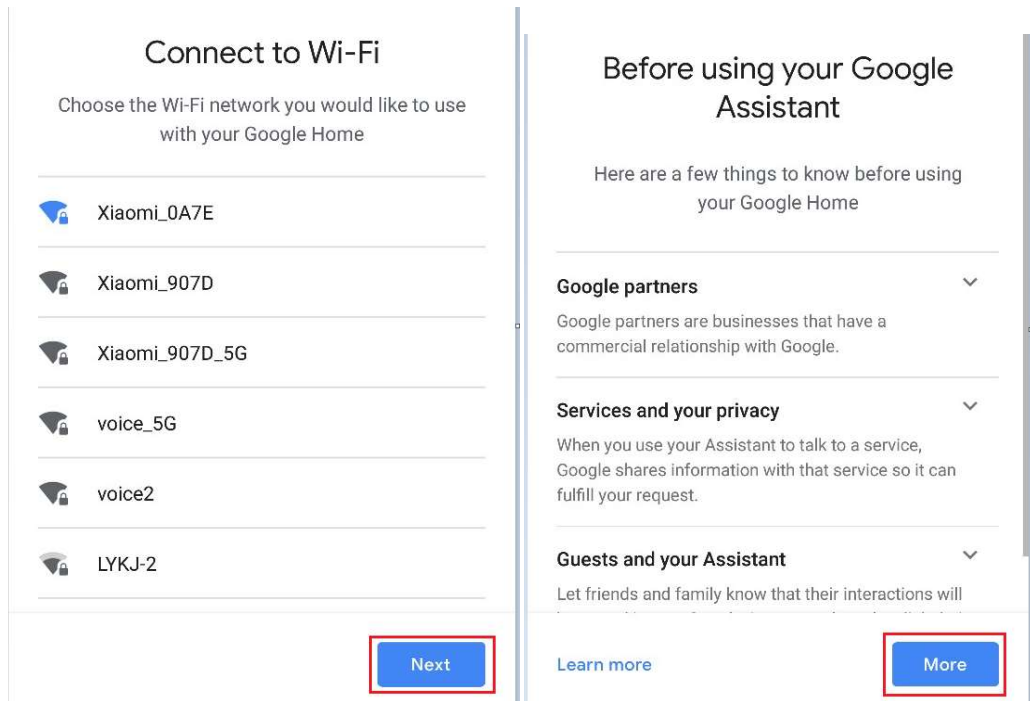

Set Google Home and click “More”.

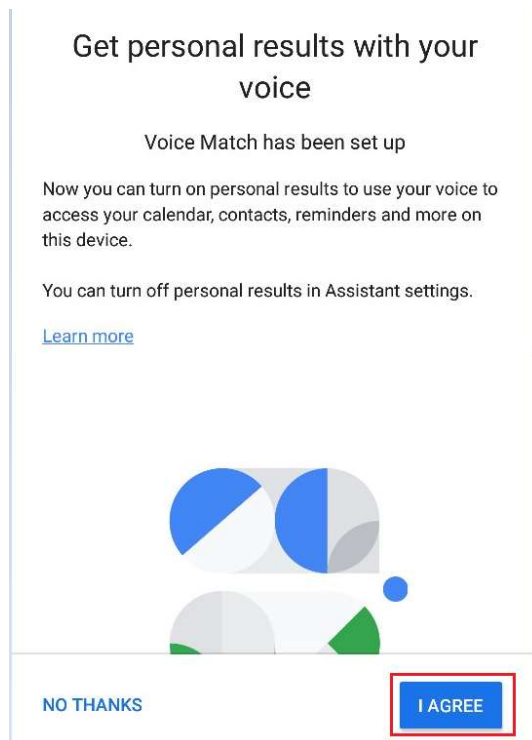

Click “I AGREE”.

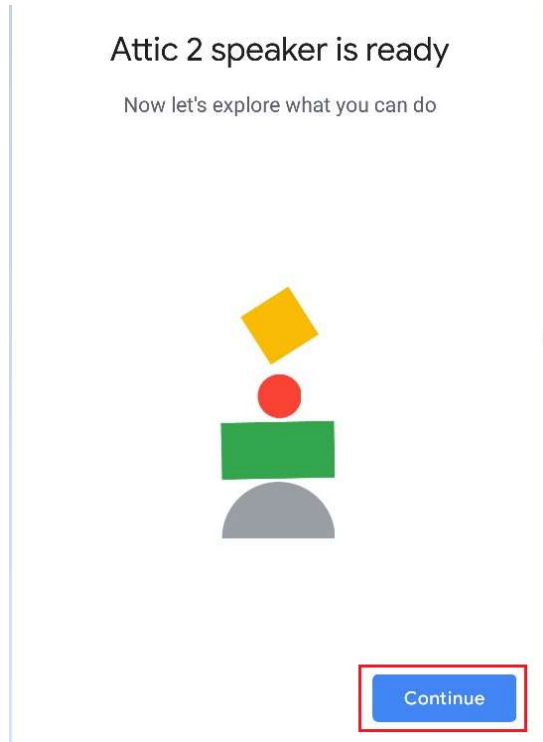

According to the prompting, choose if you agree the corresponding operation, if it displays "Google Home is ready", choose "Continue" to the next step.

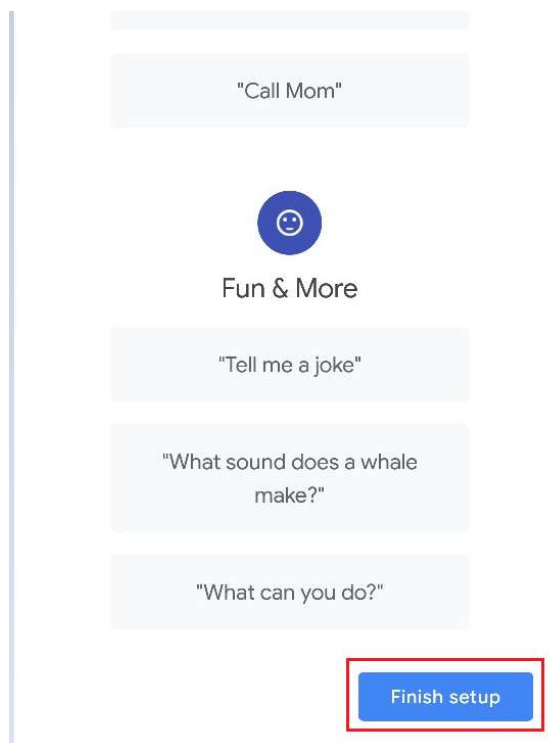

Here comes the language control guidance course, after listening, click "Finish setup", then Google Home setting is completed.

4. Add EWPE app account

- ◆ In Google Home App homepage, click “+” button.

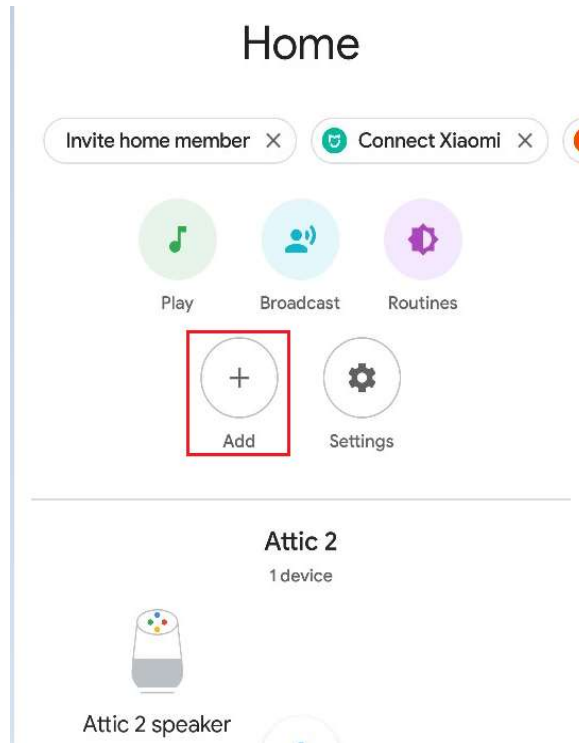

Click “Set up device”.

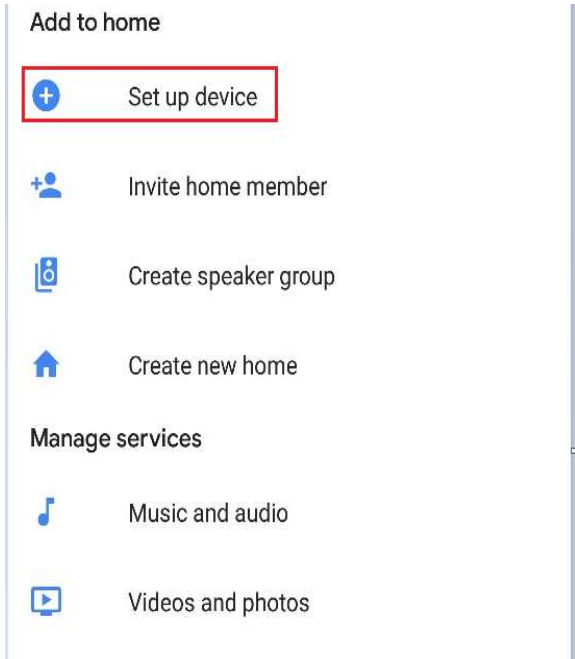

Select Works with Google.

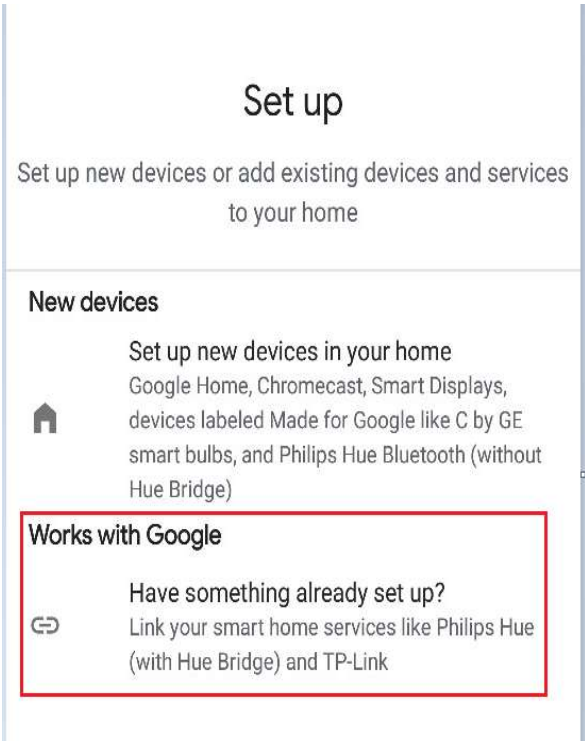

Search "Ewpe SmartHome".

Search Ewpe SmartHome on the list and click it, choose the country where your Ewpe Smart App account is, input EWPE App account and password and click “Ewpe SmartHome” to add it.

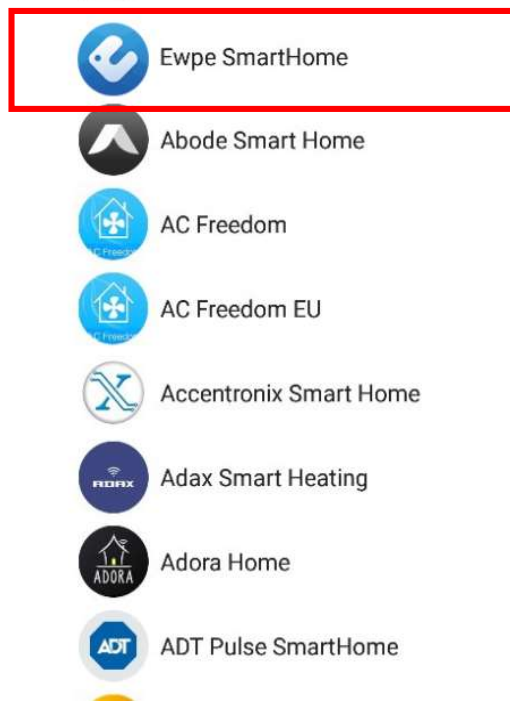

After adding, your device will appear on the device list.

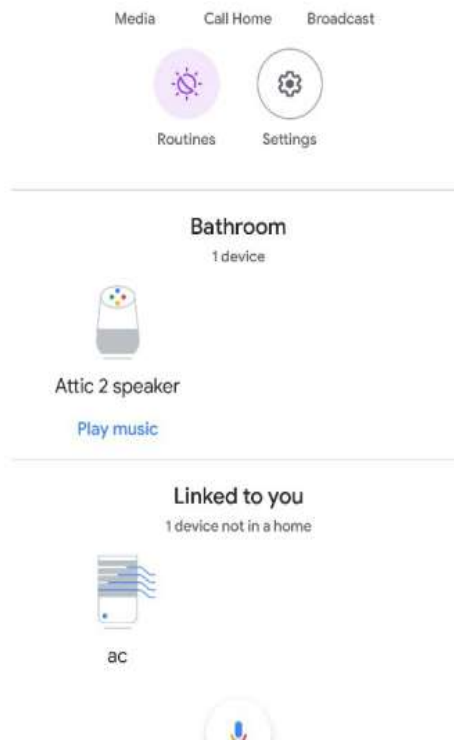

5. Use Google Home to control your intelligent device

Now, you can use Google Home to control your intelligent device.

Take Air Conditioning as an example, the supporting instruction includes:

Ok Google, turn on/off Air Conditioning.